



FEATURES

Powered for Continuous Operation: All ratings are within the working limits of the motor as recommended by the motor manufacturer. Pump can be operated continuously without damage to the motor.

Sand Handling Design: Our face clearance, floating impeller stack has proven itself for over 50 years as a superior sand handling, durable pump design.

FDA Compliant Non-Metallic Parts: Impellers, diffusers and bearing spiders are constructed of glass filled engineered composites. They are corrosion resistant and non-toxic.

Discharge Head: Cast 303 stainless steel for strength and durability. Two cast-in safety line loops for installer convenience.

Motor Adapter: Cast 303 stainless steel for rigid, accurate alignment of pump and motor. Easy access to motor mounting nuts using standard open end wrench.

Stainless Steel Casing: Polished stainless steel is strong and corrosion resistant.

Hex Shaft Design: Six sided shafts for positive impeller drive.

Engineered Polymer Bearings: The proprietary, engineered polymer bearing material is strong and resistant to abrasion and wear. The enclosed upper bearing is mounted in a durable Noryl® bearing spider for excellent abrasion resistance.

Check Valve: Screws into discharge head from the top, easily removed for drain-back systems or replacement without disassembling the pump. Spring loaded, o-ring poppet design for positive seal in all conditions.

Crimped Design: For strength, will not separate in the harshest conditions.

5CS, 7CS, 10CS, 13CS, 18CS & 25CS

5-25 GPM, ½ - 3 HP, 60 HZ, SUBMERSIBLE PUMPS

WATER END DATA

Model	Order Number	Required HP	Stages	Weight (lbs)	Length (in)
5CS	5CS05R	½	9	8	13.3
	5CS05	½	12	9	15.3
	5CS07	¾	15	11	17.4
	5CS10	1	20	13	20.8
7CS	7CS05R	½	7	6	12.1
	7CS05	½	10	7	14.2
	7CS07	¾	13	8	16.4
	7CS10	1	17	9	19.2
	7CS15	1½	22	12	24.0
10CS	10CS05R	½	5	6	10.5
	10CS05	½	7	7	11.9
	10CS07	¾	10	8	14.0
	10CS10	1	12	9	15.3
	10CS15	1½	17	12	18.8
	10CS20	2	20	13	20.8
13CS	13CS05	½	5	6	10.5
	13CS07	¾	7	7	11.9
	13CS10	1	10	8	14.0
	13CS15	1½	12	9	15.3
	13CS20	2	17	12	18.8
	13CS30	3	21	15	22.7
18CS	18CS07	¾	6	7	12.2
	18CS10	1	8	8	13.9
	18CS15	1½	11	10	16.4
	18CS20	2	14	11	19.0
	18CS30	3	19	15	23.3
25CS	25CS10	1	7	8	13.6
	25CS15	1½	9	9	15.5
	25CS20	2	11	10	17.4
	25CS30	3	15	14	21.1

NOMENCLATURE See price book for complete order numbers.

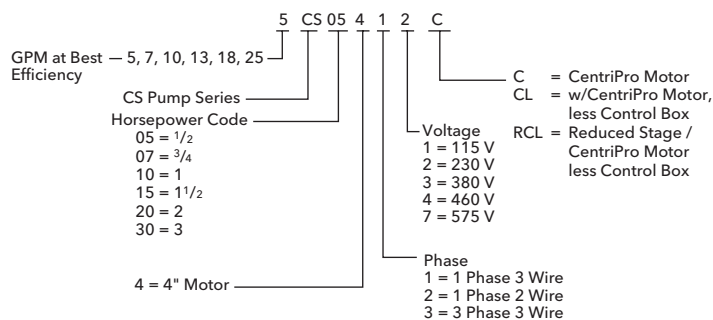

"CS" SERIES MATERIALS OF CONSTRUCTION

Part Name	Material
Discharge Head	AISI 303 SS
Check Valve Poppet	AISI 304 SS
Check Valve Seal	BUNA, FDA compliant
Check Valve Seat	AISI 304 SS
Check Valve Retaining Ring	AISI 302 SS
Bearing Spider - Upper	Noryl® GFN2
Bearing	Proprietary Engineered Polymer
Klipring	AISI 301 SS
Diffuser	Lexan®
Impeller	Noryl®
Bowl	AISI 304 SS
Shim	AISI 304 SS
Screws - Cable Guard	AISI 304 SS
Motor Adapter	AISI 303 SS
Casing	AISI 304 SS
Shaft	AISI 304 SS
Coupling	AISI 304 SS, Powder Metal
Cable Guard	AISI 304 SS
Suction Screen	Engineered Composite

SPECIFICATIONS

Model	Flow Range GPM	Horsepower Range	Best Efficiency GPM	Discharge Connection	Minimum Well Size	Rotation ^①
5CS	1.2 - 7.5	½ - 1	5	1¼	4"	CCW
7CS	1.5 - 10	½ - 1½	7	1¼	4"	CCW
10CS	3 - 16	½ - 2	10	1¼	4"	CCW
13CS	4 - 20	½ - 3	13	1¼	4"	CCW
18CS	6 - 28	¾ - 3	18	1¼	4"	CCW
25CS	8 - 33	1 - 3	25	1¼	4"	CCW

① Rotation is counterclockwise when observed from pump discharge end.
 Optional wrap-around style strainer - order number

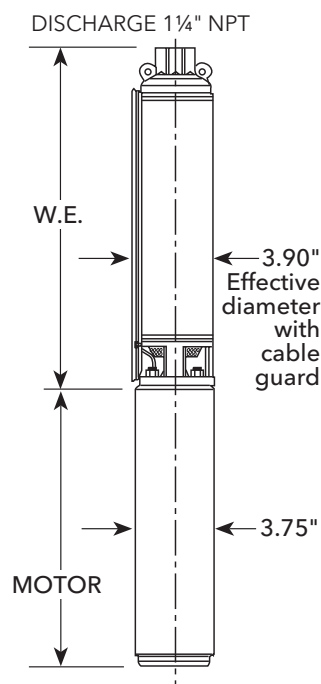

CENTRIPRO 4" SINGLE-PHASE MOTORS

Order No.	Type	HP	Volts	Length in. (mm)	Weight lb. (kg.)
M05421	2-wire PSC	½	230	11.0 (279)	20 (9.1)
M05422		½		11.0 (279)	20 (9.1)
M07422		¾		12.4 (314)	23 (10.4)
M10422		1		13.3 (337)	25 (11.3)
M15422		1.5		14.9 (378)	29 (13.2)
M05411	3-wire	½	230	10.0 (253)	19 (8.6)
M05412		½		9.7 (246)	18 (8.2)
M07412		¾		10.8 (275)	22 (10)
M10412		1		11.7 (297)	23 (10.4)
M15412		1.5		13.6 (345)	28 (12.7)
M20412		2		15.1 (383)	31 (14.1)
M30412		3		18.3 (466)	40 (18.1)
M50412	5	27.7 (703)	70 (31.8)		

NEMA MOTOR

- Corrosion resistant stainless steel construction.
- Built-in surge arrestor is provided on single phase motors through 5 HP.
- Stainless steel splined shaft.
- Hermetically sealed windings.
- Replaceable motor lead assembly.
- NEMA mounting dimensions.
- Control box is required with 3 wire single phase units.
- Three phase units require a magnetic starter with three leg Class 10 overload protection.

CENTRIPRO 4" THREE-PHASE MOTORS

Order No. by Voltage			HP	Length in. (mm)	Weight lb. (kg.)
200V	230V	460V			
M05430	M05432	M05434	½	10.8 (275)	22 (9.7)
M07430	M07432	M07434	¾	10.8 (275)	22 (9.7)
M10430	M10432	M10434	1	11.7 (297)	23 (10.4)
M15430	M15432	M15434	1.5	11.7 (297)	23 (10.4)
M20430	M20432	M20434	2	13.8 (351)	28 (12.7)
M30430	M30432	M30434	3	15.3 (389)	32 (14.5)
M50430	M50432	M50434	5	21.7 (550)	55 (24.9)
M75430	M75432	M75434	7.5	27.7 (703)	70 (1.8)

Order No.	HP	Volts	Length in. (mm)	Weight lb. (kg.)
M15437	1.5	575	11.7 (297)	23 (10.4)
M20437	2		15.3 (389)	32 (14.5)
M30437	3		15.3 (389)	32 (14.5)
M50437	5		27.7 (703)	70 (31.8)
M75437	7.5		27.7 (703)	70 (31.8)

AGENCY LISTINGS



Pump/Water End and CentriPro Motor - tested to UL778 and CAN 22.2 by CSA International (Canadian Standards Association)



CentriPro Motor - Certified to NSF/ANSI 61, Annex G, Drinking Water System Components 4P49



NSF/ANSI 372 - Drinking Water System Components - Lead Content

CLASS 6853 01 - Low Lead Content Certification Program - Plumbing Products

Model 5CS

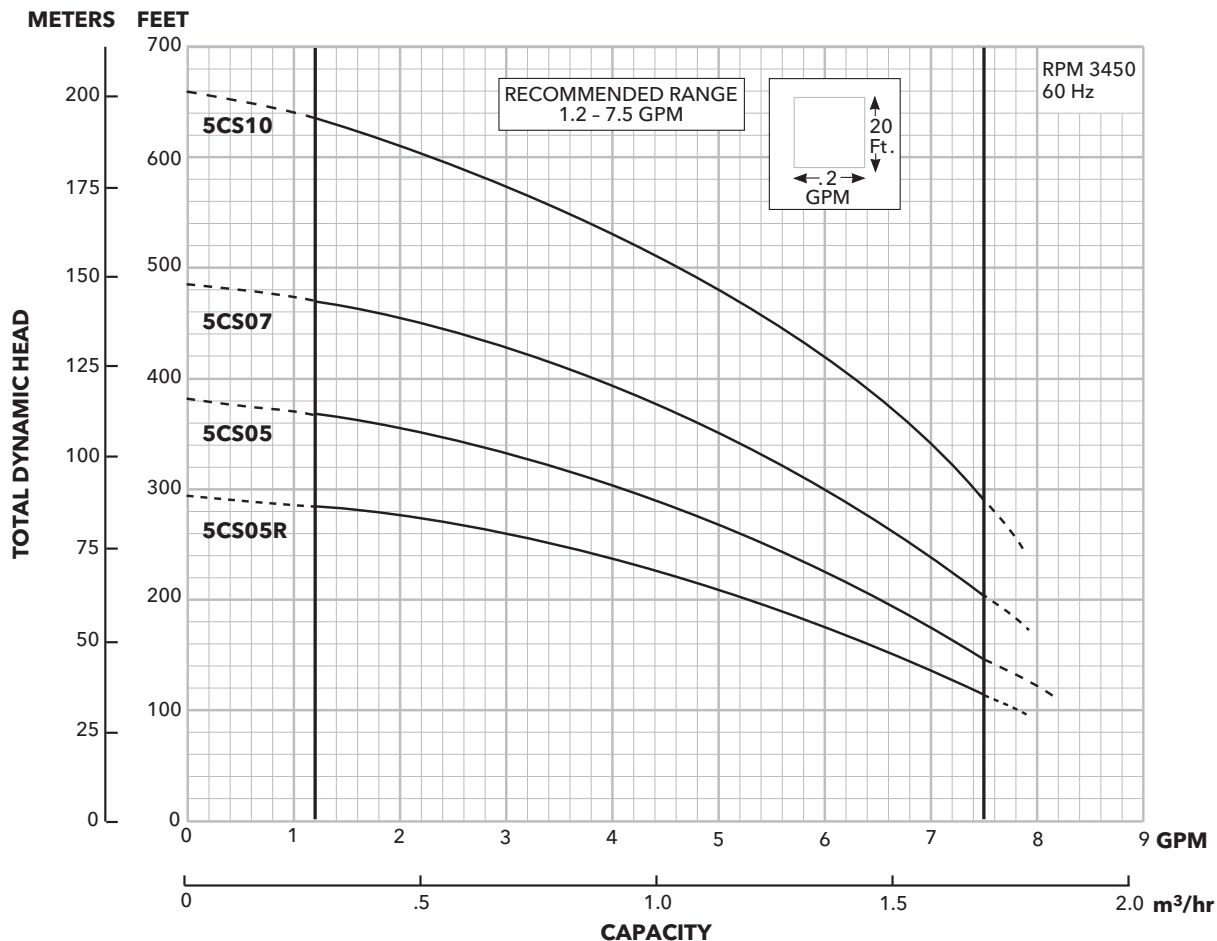

Model 7CS

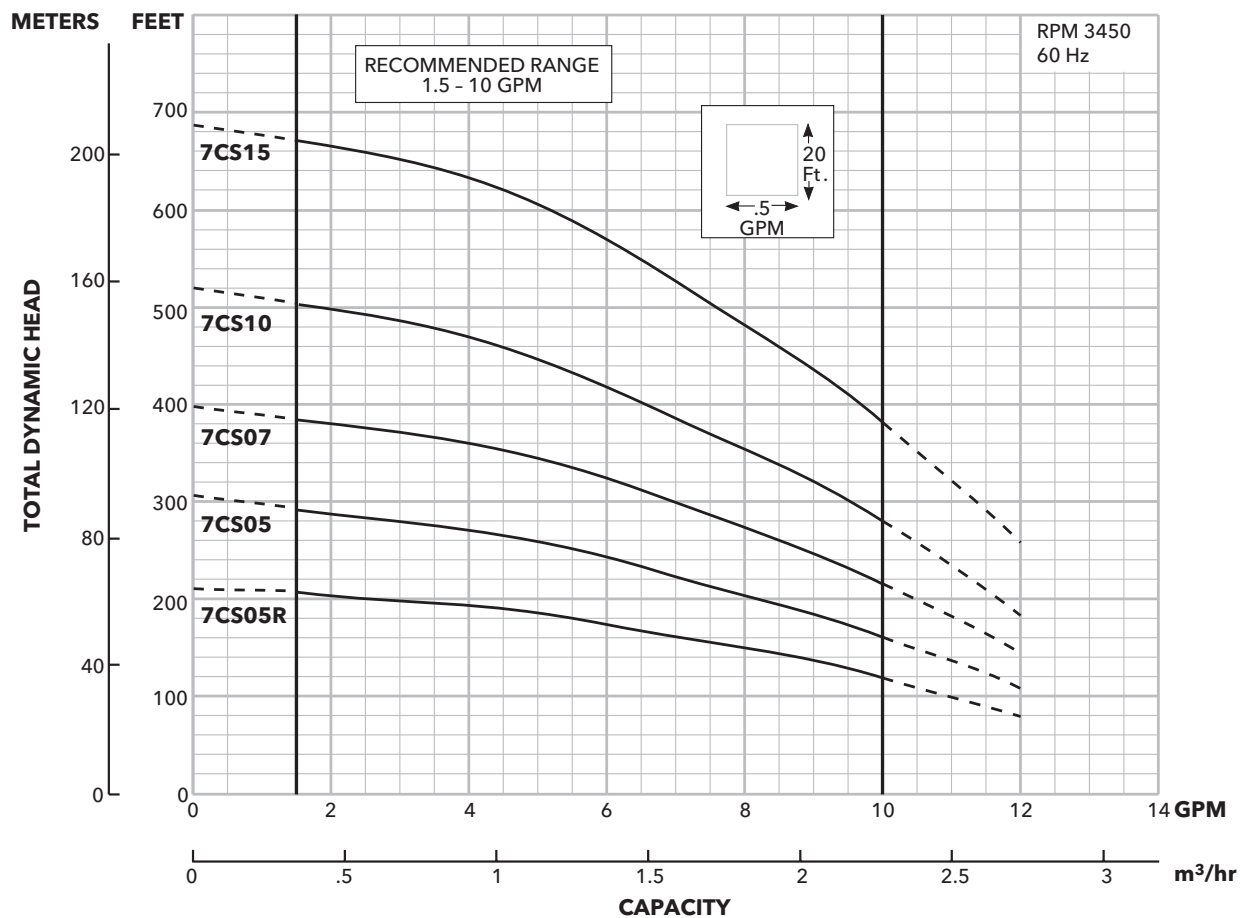

Model 10CS

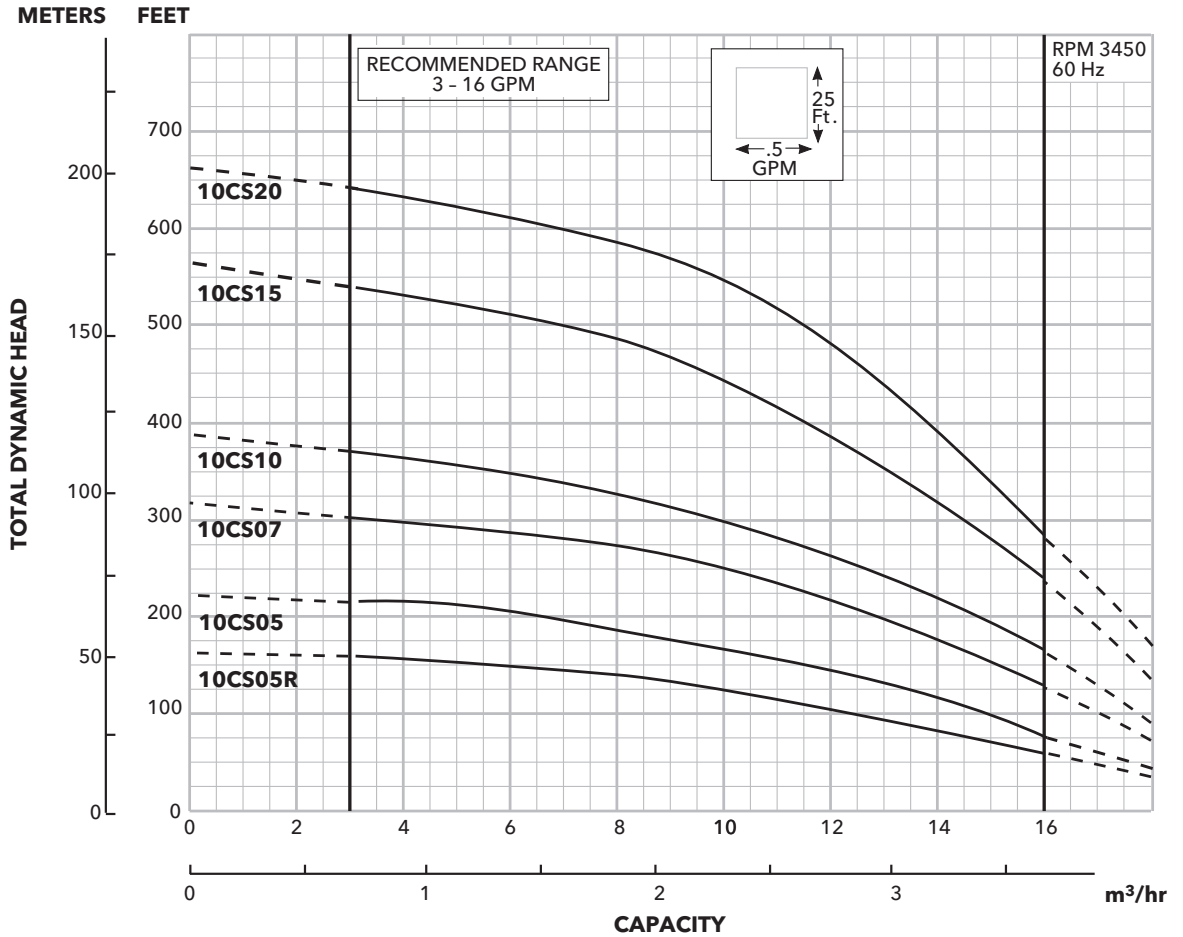

Model 13CS

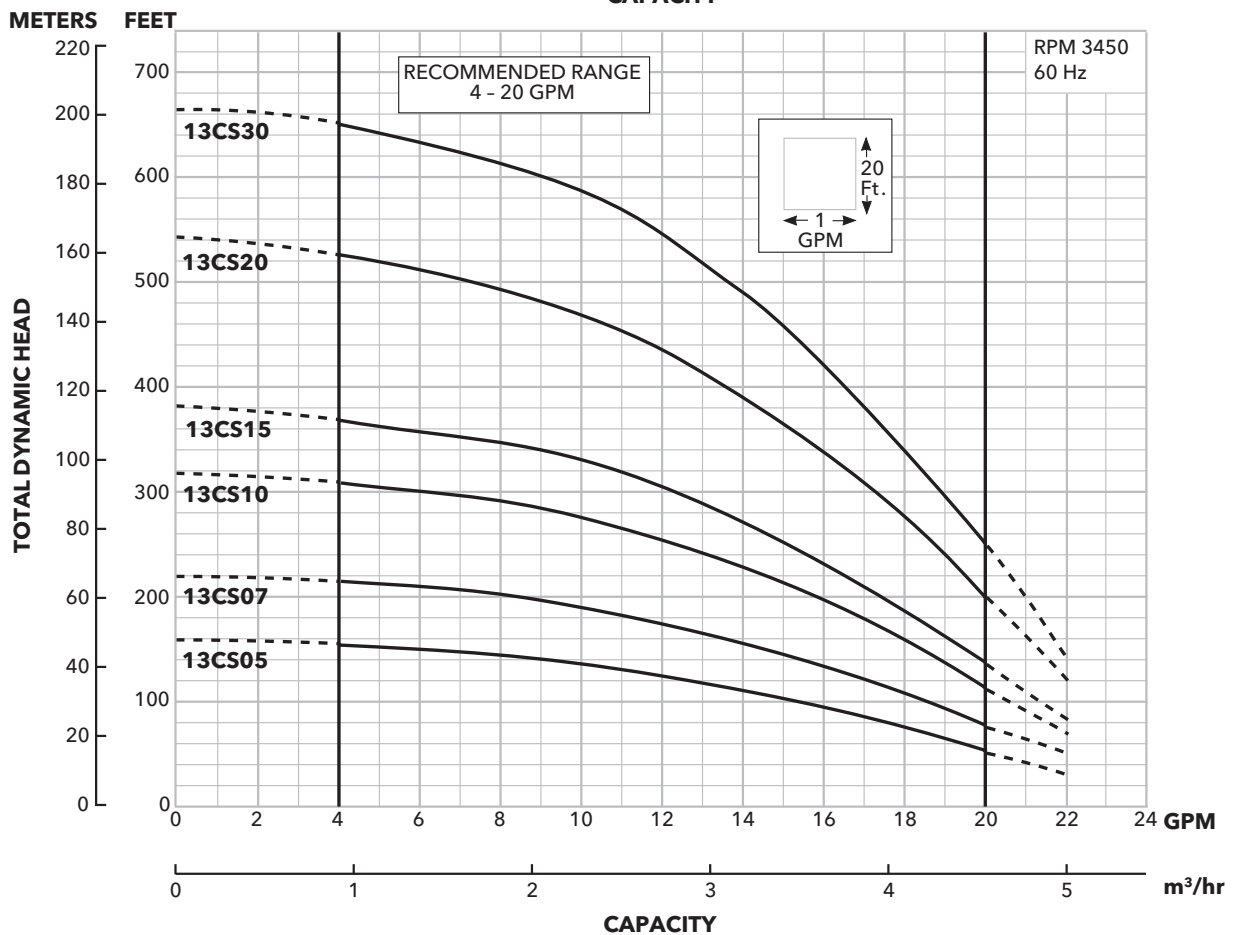

Model 18CS

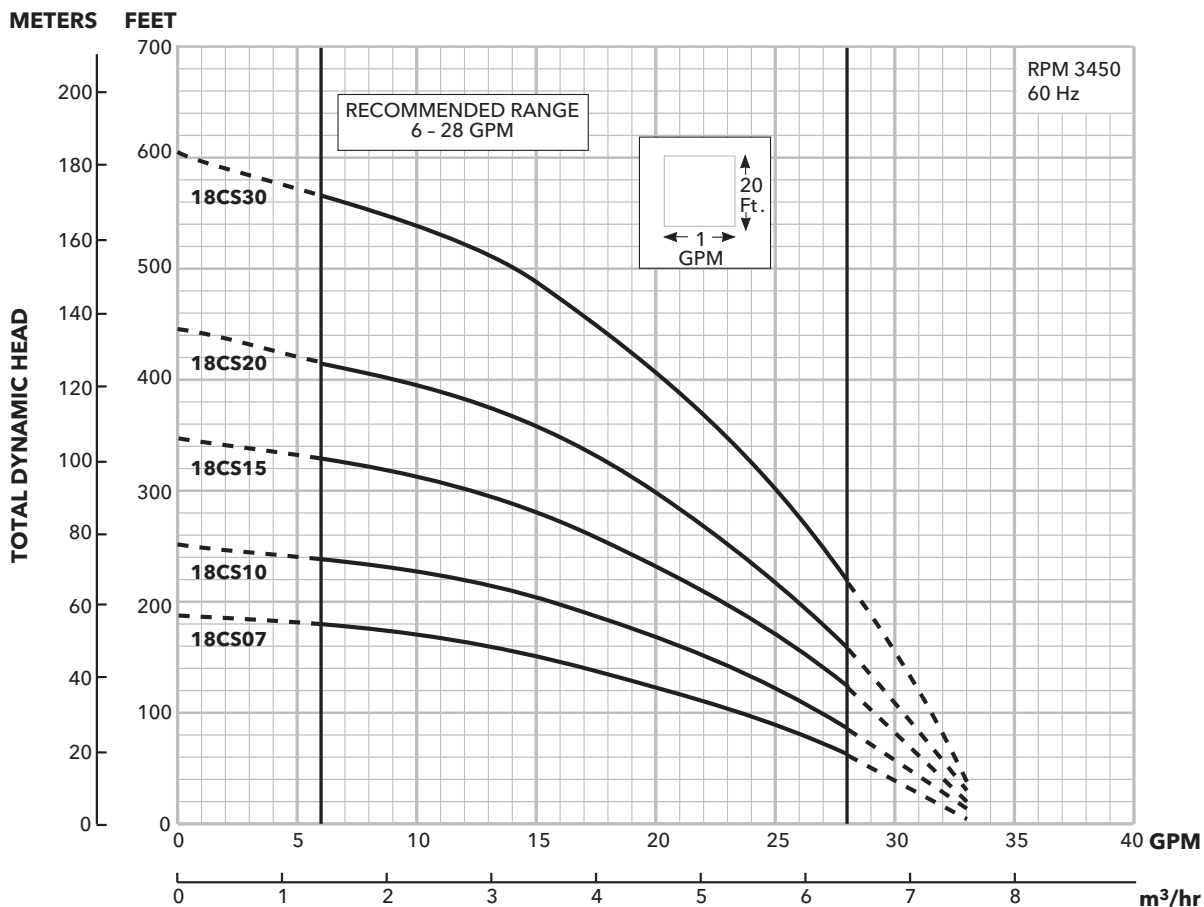

Model 25CS

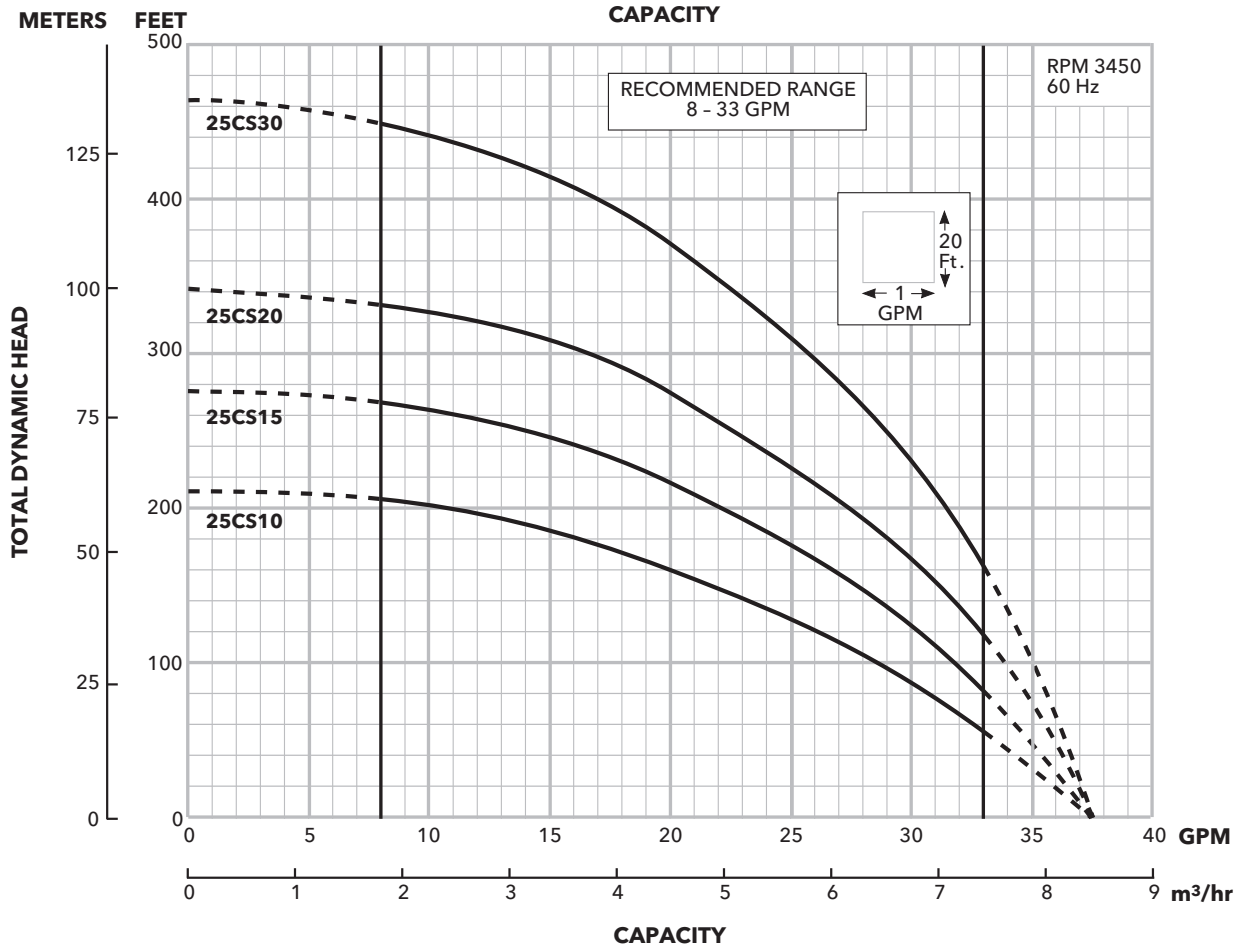

MODEL 5CS

SELECTION CHART

Horsepower Range ½ - 1, Recommended Range 1.2 - 7.5 GPM, 60 Hz, 3450 RPM

Pump Model	HP	PSI	Depth to Water in Feet/Ratings in GPM (Gallons per Minute)																																				
			20	40	60	80	100	120	140	160	180	200	220	240	260	280	300	340	380	420	460	500	540	580	620	660	700	740	780	820	860	900	940	980	1020				
5CS05R	½	0					7.4	6.9	6.3	5.8	5.3	4.7	4.0	3.0	1.4																								
		20				7.3	6.7	6.2	5.6	5.1	4.5	3.8	2.6																										
		30			7.2	6.6	6.1	5.6	5.0	4.4	3.6	2.3																											
		40	7.1	6.6	6.0	5.5	4.9	4.3	3.4	2.1																													
		50	7.0	6.5	5.9	5.4	4.9	4.2	3.3	1.8																													
		60	6.4	5.8	5.3	4.8	4.1	3.1	1.6																														
Shut-off PSI		118	109	101	92	83	75	66	57	49	40	31	23	14	5																								
5CS05	½	0					7.7	7.3	6.9	6.4	6.0	5.6	5.1	4.7	4.1	2.6																							
		20				7.5	7.1	6.7	6.3	5.9	5.4	5.0	4.5	3.9	3.2	2.3																							
		30			7.5	7.1	6.7	6.2	5.8	5.4	4.9	4.4	3.8	3.1	2.1																								
		40		7.4	7.0	6.6	6.2	5.7	5.3	4.9	4.3	3.7	2.9	1.9																									
		50	7.7	7.4	6.9	6.5	6.1	5.7	5.2	4.8	4.2	3.6	2.8	1.8																									
		60	7.3	6.9	6.5	6.0	5.6	5.2	4.7	4.2	3.5	2.6	1.6																										
Shut-off PSI		156	147	138	130	121	112	104	95	86	78	69	60	52	43	34	17																						
5CS07	¾	0								7.5	7.2	6.9	6.5	6.2	5.8	5.5	5.1	4.2	3.1	1.3																			
		20							7.5	7.2	6.8	6.5	6.1	5.8	5.4	5.0	4.6	3.6	2.1																				
		30						7.4	7.1	6.8	6.4	6.1	5.7	5.4	5.0	4.6	4.1	2.8																					
		40					7.4	7.1	6.7	6.4	6.0	5.7	5.3	4.9	4.5	4.0	3.4	1.8																					
		50				7.4	7.1	6.7	6.4	6.0	5.7	5.3	4.9	4.5	4.0	3.4	1.8																						
		60		7.6	7.3	7.0	6.7	6.3	6.0	5.6	5.3	4.9	4.4	3.9	3.3	2.6																							
Shut-off PSI			184	175	167	158	149	141	132	123	115	106	97	89	80	63	45	28	11																				
5CS10	1	0														7.5	7.0	6.5	5.9	5.3	4.6	3.8	2.8	1.6															
		20											7.6	7.4	7.2	7.0	6.4	5.9	5.2	4.5	3.7	2.6																	
		30										7.6	7.4	7.2	6.9	6.7	6.1	5.5	4.8	4.0	3.1	1.9																	
		40										7.6	7.4	7.1	6.9	6.6	6.3	5.8	5.1	4.4	3.5	2.5																	
		50								7.5	7.3	7.1	6.8	6.6	6.3	6.0	5.4	4.7	3.9	2.9	1.7																		
		60								7.5	7.3	7.1	6.8	6.5	6.3	6.0	5.7	5.0	4.3	3.4	2.3																		
Shut-off PSI								214	206	197	188	180	171	162	154	136	119	102	84	67	50	32	15																

MODEL 7CS

SELECTION CHART

Horsepower Range 1/2 - 1, Recommended Range 1.5 - 10 GPM, 60 Hz, 3450 RPM

Pump Model	HP	PSI	Depth to Water in Feet/Ratings in GPM (Gallons per Minute)																														
			20	40	60	80	100	120	140	160	180	200	220	240	260	280	300	320	340	360	380	400	420	440	460	480	500	540	580	620			
7CS05R	1/2	0						10.2	8.9	7.5	5.9	3.6																					
		20				9.8	8.5	7.0	5.3	2.5																							
		30			9.6	8.3	6.8	4.9	1.9																								
		40		9.4	8.1	6.5	4.6	1.2																									
		50	9.2	7.8	6.3	4.2	0.5																										
		60	7.6	6.0	3.8																												
Shut-off PSI			85	77	68	59	51	42	33	25	16	7																					
7CS05	1/2	0								10.1	9.2	8.3	7.4	6.3	5.0	3.4																	
		20						9.8	9.0	8.1	7.1	6.0	4.6	2.7																			
		30					9.7	8.8	7.9	6.9	5.8	4.3	2.4																				
		40			10.4	9.6	8.7	7.8	6.7	5.6	4.1	2.0																					
		50		10.3	9.4	8.5	7.6	6.6	5.4	3.8	1.7																						
		60	10.2	9.3	8.4	7.5	6.4	5.1	3.5																								
Shut-off PSI			125	116	107	99	90	81	73	64	55	47	38	29	21	12																	
7CS07	3/4	0											10.0	9.3	8.6	7.9	7.1	6.2	5.2	4.0	2.4												
		20									10.4	9.8	9.1	8.4	7.7	6.9	6.0	4.9	3.5	1.8													
		30							10.3	9.7	9.0	8.3	7.5	6.7	5.8	4.7	3.3	1.5															
		40						10.2	9.5	8.9	8.2	7.4	6.6	5.6	4.5	3.1																	
		50					10.1	9.4	8.8	8.1	7.3	6.5	5.5	4.3	2.8																		
		60				10.0	9.3	8.7	7.9	7.2	6.3	5.3	4.1	2.5																			
Shut-off PSI						140	131	122	114	105	96	88	79	70	62	53	44	36	27	18	10												
7CS10	1	0													10.1	9.6	9.0	8.5	7.9	7.3	6.7	6.0	5.3	4.4	3.4	2.1							
		20												10.4	9.9	9.4	8.9	8.3	7.7	7.1	6.5	5.8	5.0	4.1	3.0	1.6							
		30													10.3	9.9	9.3	8.8	8.2	7.6	7.0	6.4	5.7	4.9	4.0	2.8							
		40													10.3	9.8	9.2	8.7	8.1	7.5	6.9	6.3	5.6	4.8	3.8	2.6							
		50													10.2	9.7	9.2	8.6	8.0	7.4	6.8	6.2	5.4	4.6	3.7	2.4							
		60									10.1	9.6	9.1	8.5	7.9	7.3	6.7	6.0	5.3	4.5	3.5	2.2											
Shut-off PSI									166	158	149	140	132	123	114	106	97	88	80	71	62	54	45	36	28	19	10						

Horsepower Range 1 1/2, Recommended Range 1.5 - 10 GPM, 60 Hz, 3450 RPM

Pump Model	HP	PSI	Depth to Water in Feet/Ratings in GPM (Gallons per Minute)																													
			200	220	240	260	280	300	340	380	420	460	500	540	580	620	660	700	740	780	820	860	900	940	980	1020	1060	1100	1140			
7CS15	1 1/2	0									10.2	9.3	8.5	7.6	6.8	5.9	4.7	2.6														
		20								10.1	9.2	8.3	7.5	6.7	5.8	4.5	2.1															
		30							10.4	9.6	8.7	7.8	7.0	6.2	5.1	3.3																
		40					10.3	9.9	9.1	8.2	7.4	6.6	5.6	4.2	1.6																	
		50				10.3	9.9	9.4	8.6	7.7	6.9	6.0	4.9	2.9																		
		60			10.2	9.8	9.4	8.9	8.1	7.2	6.4	5.4	3.9																			
Shut-off PSI					194	186	177	168	151	134	116	99	82	64	47	30	12															

MODEL 10CS

SELECTION CHART Horsepower Range ½ - 2, Recommended Range 3 - 16 GPM, 60 Hz, 3450 RPM

Pump Model	HP	PSI	Depth to Water in Feet/Ratings in GPM (Gallons per Minute)																													
			20	40	60	80	100	120	140	160	180	200	220	240	260	280	300	340	380	420	460	500	540	580	620	660	700	740	780	820		
10CS05R	½	0			15.6	14.0	12.4	10.4	6.5																							
		20	15.4	13.5	11.5	9.2	6.0																									
		30	13.0	11.1	8.0	4.0																										
		40	11.0	7.9	3.0																											
		50	7.0																													
		60																														
Shut-off PSI			61	53	44	34	26	18	10																							
10CS05	½	0				16.0	15.3	14.3	12.8	11.3	9.0	6.4																				
		20		15.9	14.9	13.8	12.5	10.8	8.3	4.8																						
		30	15.7	14.6	13.5	12.3	10.5	7.8	4.0																							
		40	14.5	13.4	12.0	10.3	7.5	3.0																								
		50	13.0	11.5	9.8	7.2																										
		60	11.3	9.0	6.4																											
Shut-off PSI			89	81	72	63	55	46	37	29	20	11																				
10CS07	¾	0					16.0	15.2	14.3	13.4	12.5	11.5	10.3	9.0	7.0	4.0																
		20				15.8	15.0	14.0	13.0	12.3	11.2	10.2	8.5	6.0																		
		30			15.7	14.8	13.9	12.8	12.0	11.0	9.8	8.2	5.5																			
		40		15.6	14.7	13.8	12.7	11.9	10.8	9.7	8.1	5.2																				
		50	15.3	14.4	13.5	12.6	11.6	10.5	9.4	7.5	4.8																					
		60	14.3	13.4	12.5	11.5	10.3	9.0	7.0	4.0																						
Shut-off PSI			130	121	113	104	95	87	78	69	61	52	43	35	26	17	9															
10CS10	1	0								15.8	15.2	14.5	13.7	12.8	12.0	11.0	10.0	6.7														
		20						15.7	14.9	14.3	13.5	12.7	11.7	10.6	9.6	8.1	6.5															
		30				16.0	15.6	14.8	14.2	13.3	12.5	11.6	10.4	9.4	7.8	5.5	3.0															
		40			16.0	15.5	14.7	14.1	13.2	12.4	11.5	10.3	9.1	7.4	5.0	3.0																
		50			15.3	14.6	13.9	13.0	12.3	11.3	10.1	8.9	7.0	4.3																		
		60	15.8	15.2	14.5	13.7	12.8	12.0	11.0	10.0	8.6	6.7	4.0																			
Shut-off PSI			158	150	141	132	124	115	106	98	89	81	72	63	55	46	37	20														
10CS15	1½	0											15.7	15.3	14.8	14.4	13.3	12.2	10.9	9.3	7.1	3.0										
		20											16.0	15.6	15.2	14.7	14.3	13.7	13.2	11.9	10.6	9.0	6.5									
		30											15.9	15.5	15.2	14.6	14.2	13.5	13.1	12.6	11.3	9.7	7.6	4.0								
		40										15.8	15.5	15.1	14.6	14.2	13.5	13.0	12.5	11.8	10.3	8.8	6.0									
		50									15.7	15.4	14.9	14.5	14.0	13.4	12.8	12.3	11.7	11.0	9.4	7.4	3.4									
		60						15.7	15.3	14.8	14.4	13.9	13.3	12.8	12.2	11.6	10.9	10.1	8.1	5.6												
Shut-off PSI						197	188	180	171	162	154	144	136	128	119	110	93	76	58	41	24	6										
10CS20	2	0														16.0	15.7	14.9	14.2	13.4	12.4	11.4	10.0	8.2	5.8							
		20														15.9	15.5	15.3	14.8	14.1	13.2	12.2	11.0	9.9	8.0	5.2						
		30														15.8	15.4	15.1	14.7	14.4	14.0	13.5	12.7	11.7	10.3	8.8	6.5					
		40														15.8	15.4	15.1	14.7	14.4	14.0	12.9	12.2	10.9	9.5	7.8	3.9					
		50														16.1	15.7	15.3	15.0	14.6	14.2	14.0	13.4	12.5	11.5	10.1	8.5	6.0				
		60									16.0	15.7	15.3	14.9	14.5	14.2	13.8	13.4	12.8	11.8	10.7	9.1	7.2	3.4								
Shut-off PSI									225	216	208	199	190	182	173	164	156	139	121	104	87	69	52	35	17							

MODEL 13CS

SELECTION CHART

Horsepower Range ½ - 3, Recommended Range 4 - 20 GPM, 60 Hz, 3450 RPM

Pump Model	HP	PSI	Depth to Water in Feet/Ratings in GPM (Gallons per Minute)																												
			20	40	60	80	100	120	140	160	180	200	220	240	260	280	300	340	380	420	460	500	540	580	620	660	700	740	780	820	
13CS05	½	0			19.0	17.5	15.3	12.5	8.2																						
		20	18.8	16.5	14.5	12.0	8.0																								
		30	16.0	13.4	11.0	4.1																									
		40	13.3	10.6	4.0																										
		50	9.8																												
		60																													
Shut-off PSI			60	52	43	35	26	17	9																						
13CS07	¾	0				19.7	18.5	17.0	15.0	13.2	11.5	8.5																			
		20		19.4	18.0	16.4	14.8	12.9	10.5	6.0																					
		30	18.9	17.5	16.0	14.6	12.5	10.0	5.0																						
		40	17.4	15.9	14.4	12.4	9.7	4.0																							
		50	15.4	13.8	12.0	9.5																									
		60	13.2	11.5	8.5																										
Shut-off PSI			86	78	69	61	52	43	35	26	17	8																			
13CS10	1	0					19.6	18.4	17.6	16.6	15.4	14.1	12.8	11.4	9.5	6.0															
		20			20.0	19.4	18.5	17.2	16.3	15.0	13.8	12.5	11.0	8.5	4.0																
		30		20.0	19.2	18.2	17.1	15.8	14.7	13.6	12.2	10.5	7.5																		
		40	19.9	19.0	18.0	17.0	15.7	14.6	13.5	12.0	10.1	7.3																			
		50	18.8	17.8	16.8	15.5	14.5	13.0	11.6	9.9	7.0																				
		60	17.6	16.6	15.4	14.1	12.8	11.4	9.5	6.0																					
Shut-off PSI			128	119	110	102	93	84	76	67	58	50	41	32	24	15	6														
13CS15	1½	0						19.7	18.9	18.2	17.3	16.3	15.2	14.2	13.2	12.1	8.7														
		20					19.5	18.4	17.9	17.0	16.0	15.1	14.1	12.9	11.8	10.2	8.8														
		30			20.2	19.4	18.6	17.6	16.8	15.8	14.9	14.0	12.6	11.5	9.9	7.9	4.0														
		40		20.0	19.3	18.5	17.5	16.6	15.7	14.8	13.9	12.5	11.4	9.5	7.3	4.0															
		50	20.0	19.1	18.3	17.4	16.4	15.5	14.5	13.6	12.3	11.0	9.2	6.3																	
		60	18.9	18.2	17.3	16.3	15.2	14.2	13.3	12.1	11.0	8.7	5.6																		
Shut-off PSI			156	147	139	130	121	113	104	95	87	78	69	61	52	43	35	17													
13CS20	2	0									20.0	19.5	19.0	18.3	17.9	17.2	15.8	14.4	12.6	10.5	7.7										
		20									19.8	19.4	18.8	18.2	17.6	17.0	16.3	15.6	14.1	12.4	10.2	6.8									
		30									19.7	19.3	18.7	18.2	17.4	16.8	16.2	15.5	14.8	13.1	11.1	8.8									
		40									19.6	19.2	18.6	18.1	17.3	16.7	16.1	15.4	14.7	13.8	12.0	9.8	6.0								
		50										20.1	19.5	19.1	18.4	18.0	17.2	16.6	16.0	15.2	14.6	13.7	12.9	10.8	8.5						
		60			20.0	19.5	19.0	18.3	17.9	17.2	16.5	15.8	15.1	14.4	13.6	12.6	11.5	9.2	5.0												
Shut-off PSI					206	198	189	180	172	163	155	146	137	129	120	111	103	85	68	51	33	16									
13CS30	3	0													19.8	19.4	18.9	18.0	17.1	16.0	14.6	13.5	11.9	10.0	7.3						
		20													19.6	19.2	18.9	18.3	17.9	17.0	15.9	14.7	13.3	11.8	9.7	6.9					
		30														20.0	19.5	19.1	18.8	18.2	17.8	17.4	16.4	15.2	13.9	12.3	10.5	8.3	4.0		
		40														20.0	19.4	19.1	18.7	18.2	17.8	17.3	16.8	15.6	14.5	13.0	11.4	9.5	6.0		
		50														19.9	19.5	19.0	18.6	18.1	17.7	17.2	16.7	16.1	14.9	13.7	12.0	10.1	7.9		
		60														19.8	19.4	18.9	18.5	18.0	17.5	17.1	16.6	16.0	15.4	14.2	12.9	11.0	9.0	5.0	
Shut-off PSI								235	226	217	209	200	191	183	174	165	157	139	122	104	87	70	53	35	18						

MODEL 18CS

SELECTION CHART

Horsepower Range ¾ - 3, Recommended Range 6 - 28 GPM, 60 Hz, 3450 RPM

Pump Model	HP	PSI	Depth to Water in Feet/Ratings in GPM (Gallons per Minute)																													
			20	40	60	80	100	120	140	160	180	200	220	240	260	280	300	340	380	420	460	500	540	580	620	660	700	740	780	820	860	
18CS07	¾	0			28.2	26.5	24.0	21.0	17.9	13.5																						
		20	27.7	25.9	23.0	20.0	16.5	10.8																								
		30	25.0	22.0	18.8	15.7	9.5																									
		40	22.2	18.9	15.1	9.0																										
		50	18.4	15.0	7.5																											
		60	13.5	5.0																												
Shut-off PSI			74	66	58	49	40	32	23	14																						
18CS10	1	0					27.0	25.5	23.6	21.2	18.8	15.9	12.0																			
		20		28.0	26.6	25.1	22.7	20.0	17.6	14.0	10.0																					
		30	27.9	26.1	24.3	22.2	19.8	17.1	13.8	8.3																						
		40	26.0	24.1	22.0	19.7	17.0	13.1	8.0																							
		50	24.0	22.0	19.1	16.5	13.0	7.1																								
		60	21.0	18.6	15.8	12.0																										
Shut-off PSI			103	94	86	77	68	60	51	42	34	25	16																			
18CS15	1½	0						28.4	27.2	26.0	24.8	23.0	21.4	19.6	17.5	15.0	12.1															
		20				27.8	26.8	25.4	24.0	22.2	20.6	18.8	16.7	14.0	10.0																	
		30			27.7	26.5	25.3	23.8	22.0	20.2	18.5	16.1	13.5	10.0																		
		40		27.5	26.3	25.0	23.6	22.0	20.1	18.1	16.0	13.1	9.5																			
		50	27.6	26.4	25.0	23.4	21.8	20.0	18.0	15.5	13.0	9.2																				
		60	26.0	24.6	23.0	21.2	19.5	17.5	15.0	12.0	7.9																					
Shut-off PSI			143	134	126	117	108	100	91	82	74	65	56	48	39	30	22															
18CS20	2	0								28.0	27.1	26.2	25.1	24.0	22.9	21.4	20.0	16.8	12.8													
		20						27.8	26.8	25.8	24.6	23.7	22.6	21.0	19.5	18.0	16.0	11.6														
		30					27.5	26.5	25.5	24.5	23.3	22.1	20.6	19.0	17.5	15.8	13.6	6.5														
		40			28.5	27.4	26.4	25.4	24.4	23.2	22.0	20.5	18.9	17.4	15.7	13.5	11.0															
		50		28.0	27.2	26.2	25.3	24.3	23.0	21.8	20.3	18.7	17.0	15.3	13.1	10.5	6.0															
		60	28.0	27.1	26.2	25.1	24.0	22.9	21.4	20.0	18.3	16.8	14.8	12.8	9.5																	
Shut-off PSI			183	174	165	157	148	139	131	122	113	105	96	87	79	70	61	44	27													
18CS30	3	0										28.0	27.4	26.7	26.0	25.0	23.5	21.5	19.2	16.9	14.2	10.5										
		20									27.7	27.0	26.3	25.8	24.9	24.0	23.0	21.0	18.9	16.5	13.5	9.0										
		30									27.6	26.9	26.2	25.5	24.8	23.9	22.9	21.9	19.8	17.5	14.9	11.2										
		40								27.5	26.9	26.2	25.4	24.6	23.8	22.8	21.8	20.9	18.5	16.0	13.3	8.0										
		50						27.4	26.8	26.0	25.2	24.5	23.6	22.6	21.7	20.6	19.5	17.3	14.5	11.0												
		60				28.0	27.4	26.7	26.0	25.0	24.3	23.5	22.5	21.5	20.5	19.2	18.0	15.7	12.8	7.0												
Shut-off PSI					225	216	208	199	190	182	173	164	156	147	139	130	113	95	78	61	43	26										

MODEL 25CS

SELECTION CHART

Horsepower Range 1 - 3, Recommended Range 8 - 33 GPM, 60 Hz, 3450 RPM

Pump Model	HP	PSI	Depth to Water in Feet/Ratings in GPM (Gallons per Minute)																									
			20	40	60	80	100	120	140	160	180	200	220	240	260	280	300	340	380	420	460	500	540	580	620	660	700	740
25CS10	1	0			32.8	30.8	28.6	26.2	23.5	20.0	16.2	11.0																
		20	31.8	30.0	27.5	25.2	22.0	19.0	15.0	8.0																		
		30	29.6	27.2	25.0	21.6	18.0	14.0																				
		40	27.1	24.9	21.5	17.9	13.9																					
		50	24.3	21.0	17.5	13.0																						
		60	20.0	16.2	11.0																							
Shut-off PSI			82	74	65	56	48	39	30	22	13	4																
25CS15	1½	0				33.0	31.8	30.3	28.8	26.9	24.8	22.0	19.8	16.5	11.0													
		20		32.6	31.2	29.6	28.0	26.0	23.8	21.0	18.1	14.8	8.0															
		30	32.5	31.0	29.5	27.6	25.6	23.2	20.9	17.9	14.0																	
		40	30.9	29.4	27.5	25.5	23.1	20.8	17.7	13.6																		
		50	29.0	27.2	25.1	22.9	20.4	17.2	13.0																			
		60	26.9	24.8	22.0	19.8	16.5	11.0																				
Shut-off PSI			111	103	94	85	77	68	59	51	42	33	25	16	7													
25CS20	2	0					33.0	31.8	30.4	29.0	27.4	25.7	22.6	21.5	19.3	15.4												
		20				32.7	31.3	30.0	28.6	26.8	25.0	22.9	20.9	18.3	14.3	9.0												
		30			32.3	31.0	29.6	28.5	26.4	24.5	22.6	20.5	18.0	14.0	8.0													
		40			30.9	29.5	28.2	26.3	24.3	22.4	20.4	17.8	13.6	8.0														
		50		30.5	29.4	28.0	26.0	24.1	22.1	20.0	17.2	13.2																
		60	30.4	29.0	27.4	25.7	22.6	21.5	19.3	15.4	12.2																	
Shut-off PSI			139	130	121	113	104	95	87	78	69	61	52	43	35	26	17											
25CS30	3	0							33.0	32.2	31.5	30.5	29.6	28.3	27.1	25.8	22.6	19.0	14.0									
		20					32.8	32.0	31.0	30.0	29.0	27.9	26.6	25.0	23.8	21.9	20.0	12.6										
		30					32.6	31.8	30.9	30.0	28.8	27.6	26.5	24.9	23.4	21.6	19.9	15.2	8.0									
		40				32.5	31.7	30.9	29.9	28.8	27.5	26.2	24.7	23.3	21.5	19.9	17.8	11.9										
		50			32.3	31.6	30.8	29.8	28.5	27.3	26.0	24.5	23.0	21.2	19.5	17.4	11.5											
		60	33.0	32.2	31.5	30.5	29.6	28.3	27.1	25.8	24.1	22.6	20.9	19.0	16.9	14.0	10.0											
Shut-off PSI			191	183	174	165	157	148	139	131	122	113	105	96	87	79	70	53	35	18								



Xylem Inc.
 2881 East Bayard Street Ext., Suite A
 Seneca Falls, NY 13148
 Phone: (866) 325-4210
 Fax: (888) 322-5877
www.gouldswatertechnology.com

Goulds is a registered trademark of Goulds Pumps, Inc. and is used under license.
 CentriPro is a trademark of Xylem Inc. or one of its subsidiaries.
 Noryl and Lexan are trademarks of GE Plastic.
 © 2014 Xylem Inc. B5-25CS R0 December 2014